

AT546

-( )

,  
.  
,  
,

STC

STC " ( " " )

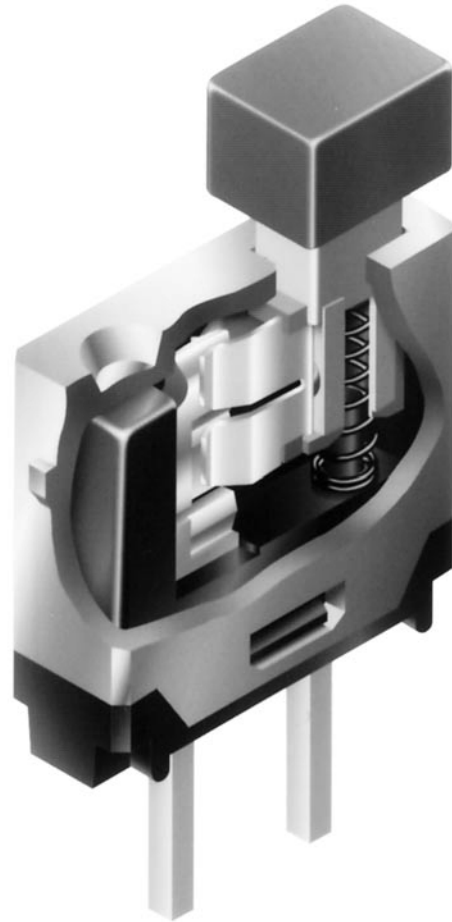

0.100" x 0.100" (2.54 x 2.54 )

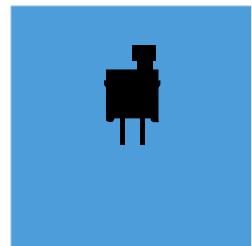

( )  
 : 0.4 / 28  
 ( 0.1 ~ 0.1A / 20 ~ 28 )  
 : " "

: 80  
 : 500 500  
 : 500 1 ;  
 : 50 000  
 : 50 000  
 : 1,0  
 : 0.020" (0.5 ) ; 0.023" (0.6 ) ; 0.043" (1.1 )

: , (UL94V-0)  
 : , (UL94V-0)  
 : , (UL94V-0)  
 : , (UL94V-0)  
 : , (UL94V-0)

: -25°C +70°C  
 : 90 ~ 95% 240 40°C  
 : 10 ~ 55 1.5 1 ; 3  
 : 50 G (490 / 2) ( , 5 )

: A " " A " "  
 : A " " " "

UL : , GB2 UL94V-0 UL CSA  
 CSA

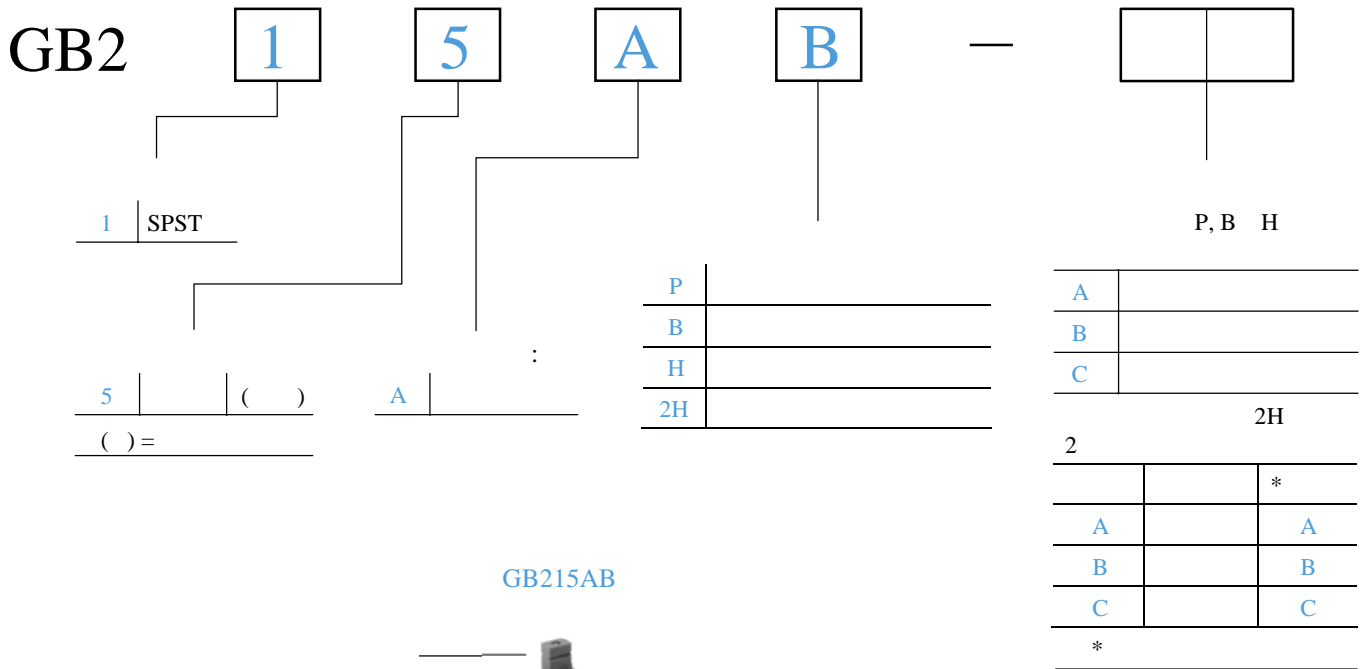

**GB215AB**

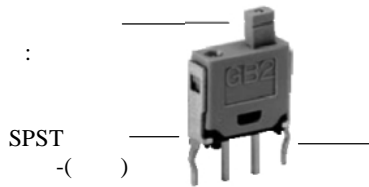

		( ) =				
SP	<b>GB215</b>		( )	OPEN	1-2 1-2 3-4	SPST SPST 2



**GB215AP**

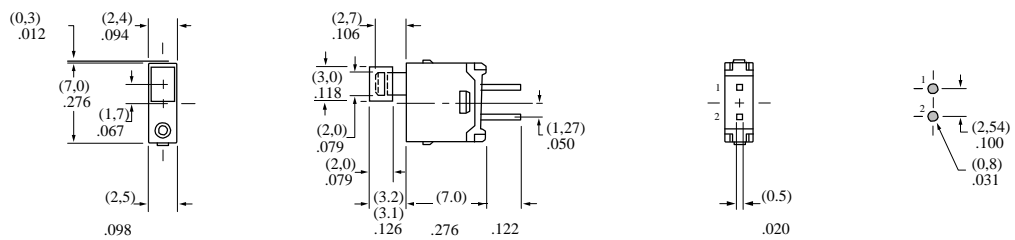

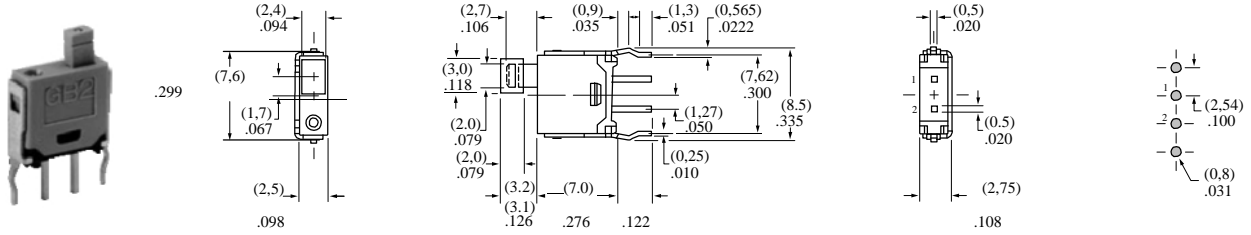

GB215AB

1

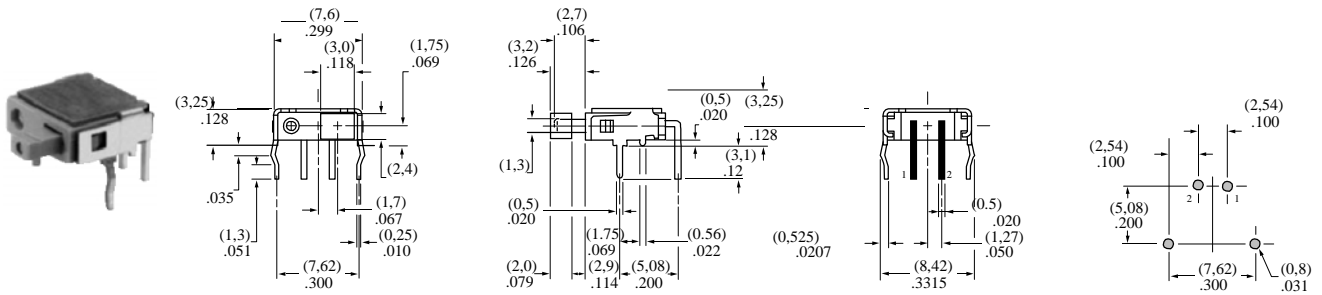

GB215AH

2

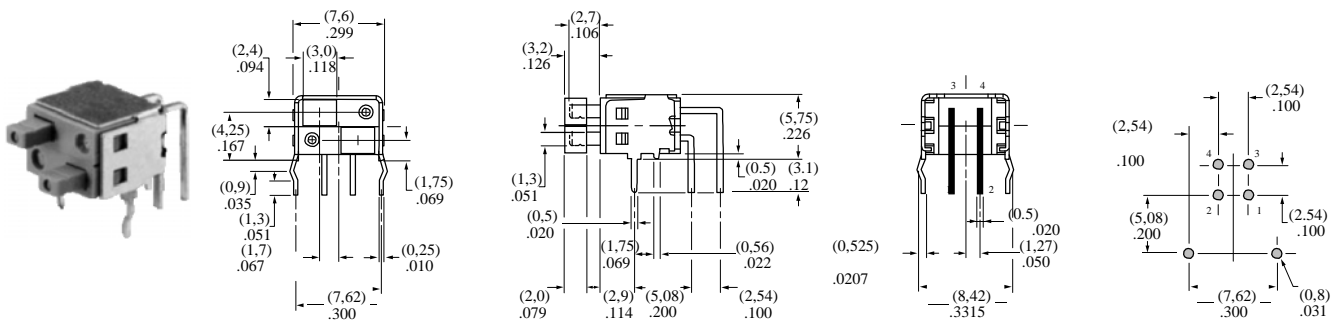

GB215A2H

A AT4137

B AT4137

C AT4137



AT546

